

## ULTRAHEAT®T230 ULTRACOLD®T230



### Technical description

32 18 101 001 e

Date: 24.10.2018

Landis+Gyr GmbH

## Outstanding features

Meter for measurement of flow and energy in a heat or cold circuit with water using the ultrasonic principle.

Important properties are:

- Non-wearing due to non-moving parts
- Measuring range of 1:100 according to EN1434:2007, 1:1.000 total range
- Temperature measurement
- Easy installation and read out
- Removable electronic unit
- Large, easy readable display
- Flow measurement with maximum values
- 2 set days for in whole 24 months (can be parameterized)
- Yearly set day (can be parameterized)
- Battery lifetime up to 11 years
- Optical interface according to EN 62056-21:2003
- Communication interfaces for remote readout or system connection
- Self-diagnosis

# Contents

<b>1</b>	<b>General notes</b> _____	<b>4</b>
	Other available documents _____	4
<b>2</b>	<b>Safety information</b> _____	<b>5</b>
<b>3</b>	<b>Technical Data</b> _____	<b>7</b>
	Dimensions (qp 0.6 – 2.5 m <sup>3</sup> /h) _____	8
<b>4</b>	<b>Installation</b> _____	<b>9</b>
	Installation Notes _____	9
	Examples of installation (directly immersed sensor) _____	10
	Installation notes for sensor adapter set _____	11
	Asymmetric mounting (temperature sensor) _____	11
4.1	Installation for cooling metering and combined heat/cooling meters _____	11
<b>5</b>	<b>Dimension of electronic unit</b> _____	<b>12</b>
<b>6</b>	<b>Operating elements</b> _____	<b>14</b>
6.1	Displaying current meter status _____	14
	User loop "LOOP 0" _____	14
	Current values "LOOP 1" _____	15
	Previous month's values "LOOP 2" _____	15
	General / Communication "LOOP 3" _____	16
	Other "LOOP 4" _____	16
6.2	Monthly values _____	16
<b>7</b>	<b>Resolution of the display</b> _____	<b>17</b>
<b>8</b>	<b>Power supply</b> _____	<b>17</b>
<b>9</b>	<b>Communication</b> _____	<b>18</b>
	Electronic unit interfaces _____	18
9.1	M-Bus _____	18
9.2	Pulse output _____	18
9.3	Wireless M-Bus _____	19
	Data telegram F000 – stationary radio (sending interval 15 min.) _____	19
	Data telegram F001 – mobile data reading (sending interval 20 sec., battery life time 6 years) _____	19
	Data telegram F002 – mobile data reading (sending interval 20 sec., battery life time 11 years) _____	20
<b>10</b>	<b>Error codes</b> _____	<b>21</b>
<b>11</b>	<b>Order codes (type number key)</b> _____	<b>22</b>
<b>12</b>	<b>Additional ordering information for wireless M-Bus</b> _____	<b>23</b>
<b>13</b>	<b>Pressure loss</b> _____	<b>25</b>

## 1 General notes



**Note:** In the text below, the term meter refers both to the heat meter and to the cooling meter and the combined heat and cooling meter, unless otherwise specified.

The meter is used as a meter for heating or cooling consumption measurement in systems with water.

The meter consists of a high-tech composite volume measurement unit, two temperature sensors connected in a fixed position and an electronic unit that calculates the energy consumption from the volume and temperature difference.

This technology is thus wear free, robust and largely maintenance free. High precision and long-term stability guarantee precise and equitable cost accounts.

### Other available documents

---

- Operating and Installation Instructions T230
- Respective module operating and installation instruction
- Illustrated catalogue

Additional information's are available on request.

---

## 2 Safety information



The meter may only be used in building service engineering systems and only for the applications described.



The local regulations (installation etc.) must be adhered to.



The operating conditions according to the type plate must be complied with during use. Non-compliance can result in hazardous situations and the expiry of all claims arising from liability for defects as well as liability based on any expressly granted guarantees.



Do not under any circumstances carry out welding, drilling or soldering work close to the meter.



Adhere to the requirements regarding circulating water (CEN / TR 16911:2016).



The meter is only suitable for circulating water in heating systems.



The meter is not suitable for drinking water.



Only personnel, trained in the installation and operation of meters in heating and cooling systems, may install and remove the meter.



Only install or remove the meter when the pipes are pressureless.



After installing the meter, check the leak-tightness of the system.



Guarantee and calibration validity will lapse if the calibration relevant security seal is broken.



Only clean the meter from outside with a soft, lightly wetted cloth. Do not use any spirit or cleaning solvent.



As far as disposal is concerned, the meter is a waste electronic appliance in the sense of European Directive 2012/19/EU (WEEE) and it must not be disposed of as domestic waste. The relevant national, legal regulations must be observed as the appliance must be disposed of via the channels provided for this purpose. The local and currently valid legislation must be observed.



The meter contains lithium batteries. Do not dispose of the meter and the batteries with domestic waste. Observe the local stipulations and laws on disposal.



You can return the lithium batteries to the manufacturer for appropriate disposal following use. When shipping please observe legal regulations, in particular, those governing the labeling and packaging of hazardous goods.



Do not open the batteries. Do not bring batteries into contact with water or expose to temperatures above 80 °C.



The meter does not have any lightning protection. Ensure lightning protection via the in-house installation.

### 3 Technical Data

<b>General</b>	
Measuring accuracy	Class 2 or 3 (EN 1434)
Environment class	A (EN 1434) for indoor installation
Mechanical class	M1 *)
Electromagnetic class	E1 *)
*) according to 2014/32/EU Directive on Measuring Instruments	
Ambient humidity	< 93% rel. humidity at 25 °C, without condensation
Max. height	2000 m above sea level
Storage temperature	-20 ... 60 °C
<b>Electronic unit</b>	
Ambient temperature	5 ... 55 °C
Housing protection rating	IP 54 according to EN 60529
Power supply	Battery for 6 or 11 years
Operation threshold for $\Delta T$	0.2 K
Temperature difference $\Delta T$	3 K ... 80 K
Temperature measurement range	0 ... 180 °C
LCD	7 digit
Optical interface	Standard, EN 62056-21
Communication	Optional
Separability	Always, cable length 1.5 m
<b>Temperature sensor</b>	
Type	Pt 500 according to EN 60751, not detachable
Connection type	Pt 500, 2 wire technology
Cable length	1.5 m (optional 5 m)
Construction type	Bulb sensor $\varnothing$ 5.2 x 45 mm
Temperature range	0 ... 95 °C
<b>Volume measurement unit</b>	
Protection class	IP 65 according to EN 60529
Mounting place	Hot side / cold side
Installation position	Any
Flow straightening	None
Measuring range	1:100
Temperature range	5 ... 90 °C
	National type approvals may be different.
Maximum overload	$q_s = 2 \times q_p$ , permanent
Nominal pressure	PN16 (1.6 MPa; PS16)
<b>qp m³/h</b>	<b>Overall length and connection</b>
0.6	110 mm (3/4 ")
1.5	110 mm (3/4 ")      130 mm (1 ")
2.5	130 mm (1 ")

Nominal flowrate $q_p$	Overall length	Connection	Maximum flowrate $q_s$	Minimum flowrate $q_i$	Response threshold (variable)	Pressure loss at $q_p$	Kv flowrate at $\Delta p$ 1 bar	Kv flowrate at $\Delta p$ 100 mbar	Weight
m <sup>3</sup> /h	mm	G/DN	m <sup>3</sup> /h	l/h	l/h	mbar	m <sup>3</sup> /h	m <sup>3</sup> /h	g
0.6	110	G 3/4	1.2	6	1.2	75	2.2	0.7	520
1.5	110	G 3/4	3	15	3	135	4.1	1.3	520
1.5	130	G1	3	15	3	135	4.1	1.3	560
2.5	130	G1	5	25	5	135	6.8	2.2	560

Tolerance of pressure loss: +/- 5%

Dimensions (qp 0.6 – 2.5 m<sup>3</sup>/h)

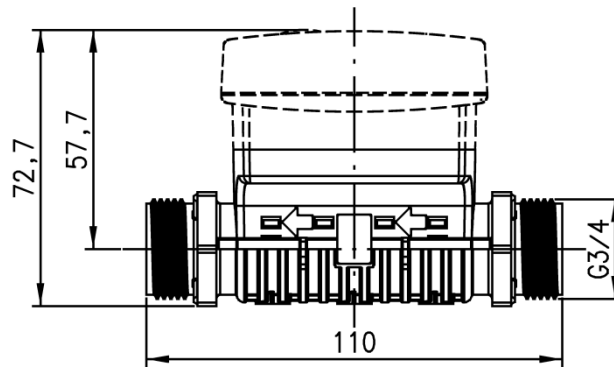

Fig. 1: Overview dimensions overall length 110 mm

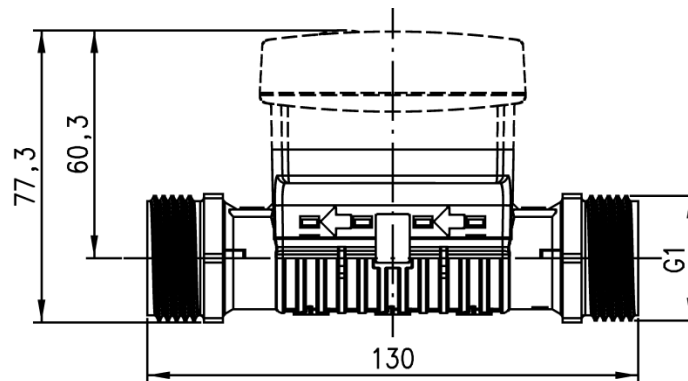

Fig. 2: Overview dimensions overall length 130 mm

Order-No.	qp	PN	Overall length
	m <sup>3</sup> /h	bar	mm
T230-x05	0.6	16	110
T230-x21	1.5	16	110
T230-x26	1.5	16	130
T230-x36	2.5	16	130





## 4 Installation



To install the meter proceed as follows:

- Determine the place of installation in line with the inscription on the meter.



**Note:** For a **heating meter** the mounting place of the flow sensor cold side is equivalent to return . The mounting place of the flow sensor hot side is equivalent to flow .



**Note:** For a **cooling meter** the mounting place of the flow sensor hot side is equivalent to the return . The mounting place of the flow sensor cold side is equivalent to flow .

- Observe the dimensions of the meter and check whether there is sufficient space available.
- Rinse the system thoroughly before installing the meter.
- Fit the meter vertically or horizontally between two slide valves so that the arrow on the housing and the flow direction match. Also observe the installation situations and the following examples of installation.



**Note:** Only use the rubber EPDM flat seals that are supplied.

- The meter must not be exposed to tensions or forces caused by pipes or fittings. If this cannot be permanently guaranteed, it is necessary to improve the point of installation or fix the lines in position, by means of suitable connecting brackets for example.
- Fit the temperature sensors in the same circuit as the meter.
- Seal the temperature sensor and the fittings to protect against manipulation.
- If you install the meter for cooling metering, follow the appropriate notes.

**Recommendation:** If you are installing several meters, the same installation conditions must be consistent for all meters.

### Installation Notes

Inlet or outlet sections are not necessary. If you install the meter in the common return of two circuits, determine a place of installation with a minimum distance of  $10 \times DN$  from the T-piece. This distance ensures a good thorough mixing of the different water temperatures. You can install the temperature sensors in T-pieces, ball valves, directly immersed or in pockets depending on the version. The temperature sensor ends must reach to at least the middle of the pipe cross section.



**Note:** Protect the meter against damage through impacts or vibrations at the place of installation.

Examples of installation (directly immersed sensor)

You can install the meter in any position e.g. vertically or horizontally. In order to avoid accumulation of air and disruption in operation, fit the meter in a vertical installation position and not in the uppermost area of a pipeline.

\* This position is not permitted for cold meters and in cases where moisture can enter the electronic unit due to condensation (e.g. during an interruption in the summer).

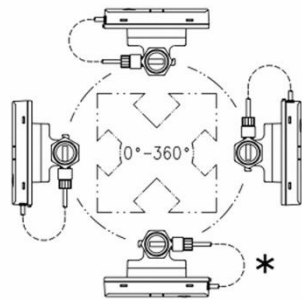

Fig. 3:

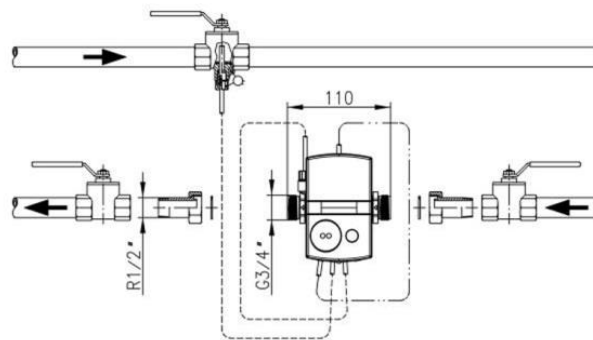

Fig. 4:

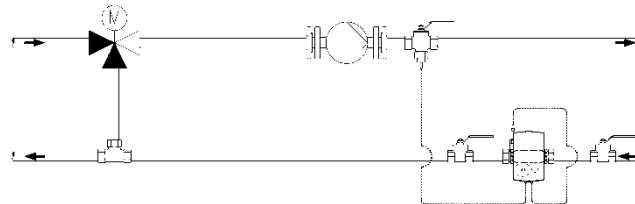

Fig. 5: Installation for circulation with admixing; placement of temperature sensors

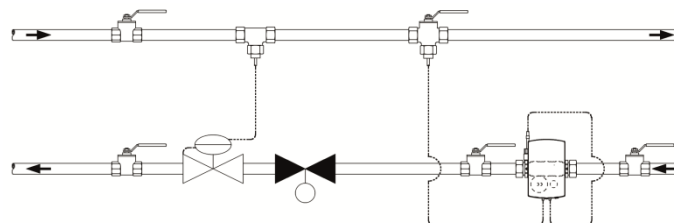

Fig. 6: Installation for circulation with throttling configuration (flow sensor in flow direction before control valve / differential pressure regulating valve)

Installation notes for sensor adapter set

A mounting set is included for meters with 5.2 × 45 mm temperature sensor. With this you can fit the temperature sensor directly immersed into an insert or a ball valve for example.

1. Install with O-ring at the point of installation with the fit-up aid/pen provided.
2. Place both halves of the plastic bolting round the 3 notches of the temperature sensor.
3. Press the bolting together and screw the bolting hand tight into the point of installation until it comes to a stop (tightening torque 3 ... 5 Nm).

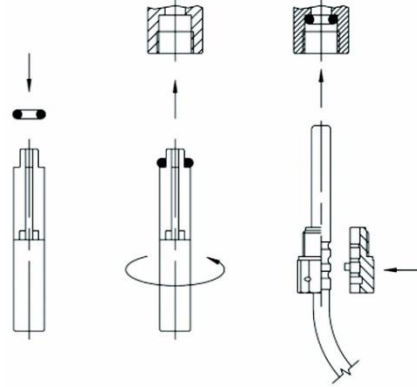

Fig. 7: Mounting adapter set

Asymmetric mounting (temperature sensor)

The meter can be mounted asymmetric, too. This means one temperature sensor is directly immersed in the volume measuring tube, whereas the other temperature sensor is mounted in a protection pocket. For the lower value of the temperature difference is then 5 K valid at the respective lower flow limit  $q_l$ . For this kind of installation the mentioned protection pockets must be used. Furthermore the national regulations of the respective country have to be observed.

Type of protection pocket	Inside diameter [mm]	Rack length from upper edge [mm]	Thread size [mm]
SPX/50/5.2	5.2	42	1/2"
WZT-M35	5.2	46	1/2"
JUMO 00420848	5.2	46	1/2"
WZT-M50	5.2	50	1/2"
JUMO 00326403	5.2	50	1/2"
1/2" SPX-TH *)	5.2	37	1/2"

\*) The sensor pocket must be installed in isolation.

4.1 Installation for cooling metering and combined heat/cooling meters

Fit the electronic unit separate to the volume measurement unit, e.g. on the wall for water temperatures below 10° C. Make a loop downwards in order to prevent condensation running along the connected lines into the electronic unit. Install the temperature sensors into the pipe from below.



**Note:** Wall adapter plates are available as an accessory.

## 5 Dimension of electronic unit

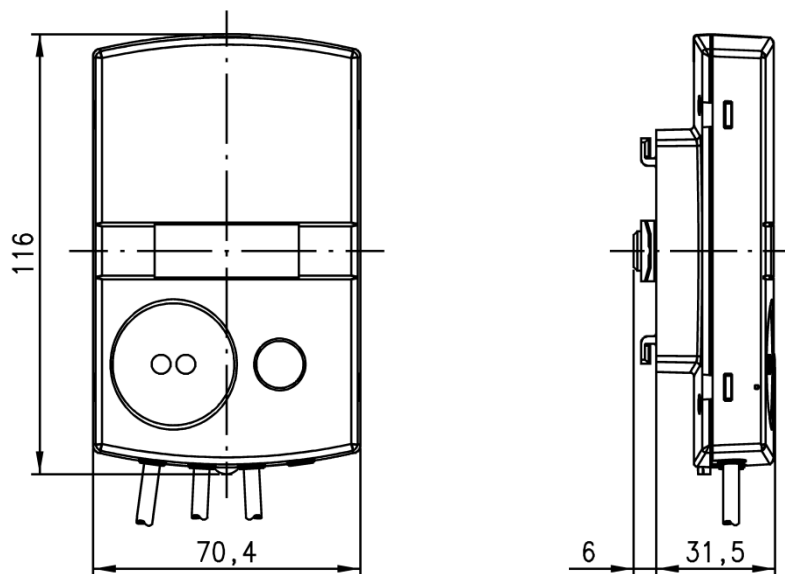

Fig. 15: Dimensions of electronic unit

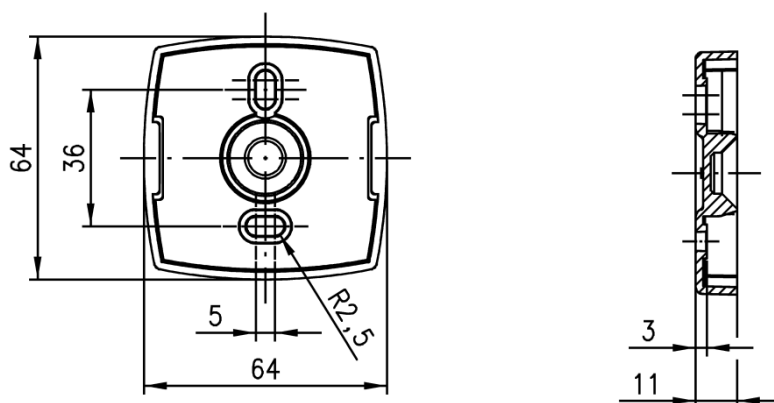

Fig. 16: Wall adapter (view from above and side)



**Note:** Wall adapter plates are available as an accessory.

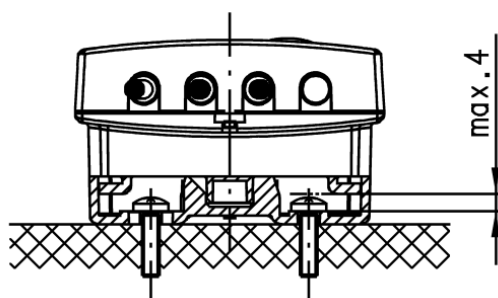

Fig. 17: Maximum screw head height (if using the wall bracket)

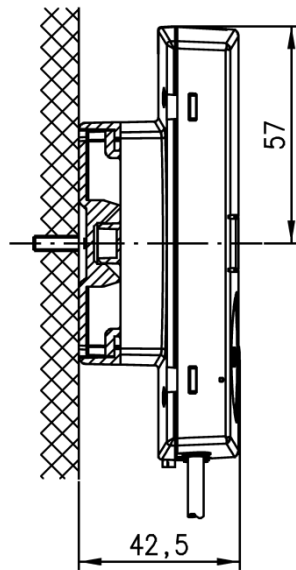

Fig. 18: Wall mounting

## 6 Operating elements

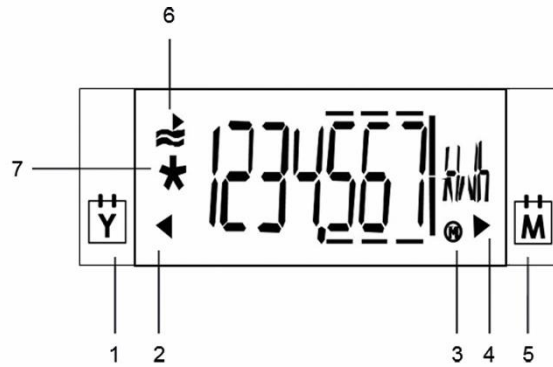

Fig. 17: LCD

No.	Description
1	Identification previous year value
2	Previous year value
3	Maxima
4	Previous month value
5	Identification previous month value
6	Activity display at flow
7	Calibrated value

### 6.1 Displaying current meter status

The meter displays the current meter status in kWh, MWh, MJ or GJ.



**Note:** In order to prevent reading errors, the decimal places of the values displayed are marked with a frame.



**Note:** Calibrated values can be recognized by an additionally displayed star symbol.



**Note:** Both display range and data displayed can differ from the description depending on the appliance parameterization. Certain button functions can also be blocked.

#### User loop "LOOP 0"



User loop



Energy quantity



Cooling registers (optional)



Volume



Segment test



In case of error: message with error code

Current values "LOOP 1"

LOOP 1	Current values
1234 m <sup>3</sup> /h	Current flow
300 kW	Current heat power
670 °C	Alternate current temperature hot and cold side in 2 s cycles
460 °C	
210 K	Temperature difference
bd 1234 h	Operating time with flow
Fd 123 h	Missing time
Pd 1234 h	Time with flow

Previous month's values "LOOP 2"



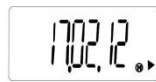



LOOP 2	Previous month's values
0102.12 M	Log date
1234567 kWh	Energy quantity
1234567 kWh	Cooling registers at the reporting date (optional)
cold	
1234567 m <sup>3</sup>	Volume on set day
Fd 123 h	Missing time on set day
38991 m <sup>3</sup> /h	Max. flow on set day in 2 s cycles with date stamp
1701.12	
1000 kW	Max. power in 2 s cycles with date stamp
1701.12	
810 °C	Max. temperature hot side in 2 s cycles with date stamp
1702.12	
660 °C	Max. temperature cold side in 2 s cycles with date stamp

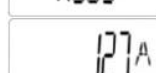

---

 General / Communication “LOOP 3“
 

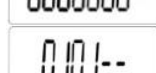
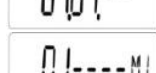
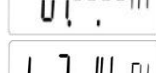

---

	General / Communication
	Device number, 7-digit
	Optional interface
	Primary address (only for M-Bus)
	Secondary address 7-digit - for M-Bus
	Yearly set day
	Monthly set day
	Firmware version
	CRC-Code

---

 Other “LOOP 4“
 

---

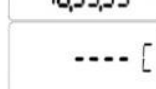
	Other
	Date
	Time
	Code entry for test / para operation

## 6.2 Monthly values

The meter stores the following values for 24 months on the monthly set day

- Energy
  - Volume
  - Missing time
- and the maxima with date stamp for
- Flow
  - Power
  - Temperature hot side
  - Temperature cold side

The monthly values can be read via optical interface.



**Note:** Central European Time (CET) applies as the standard time. During summer time the storage takes place at the corresponding times.



## 7 Resolution of the display

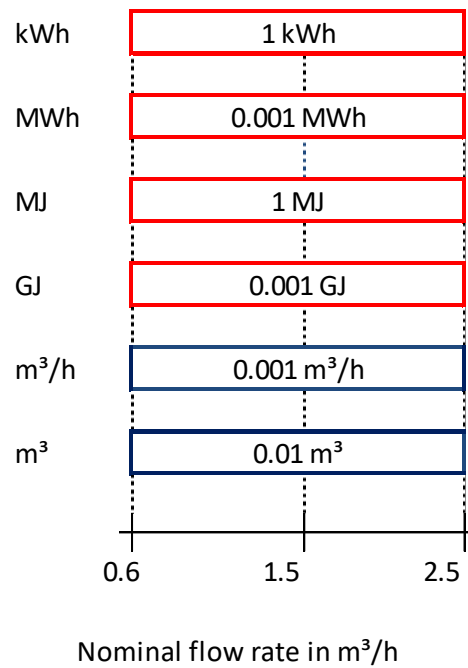

**Note:** The number of places after the decimal point of a value is based on the chosen measurement path and the chosen dimension.

## 8 Power supply

The meter is equipped with batteries.

### Options:

- 6 years battery
- 11 years battery

## 9 Communication

### Electronic unit interfaces

The meter is equipped with an optical interface in accordance with EN 62056-21:2002 as standard.



**Note:** You can find further information in their respective documentation.

#### 9.1 M-Bus

If the meter is equipped with the option M-Bus, it is supplied with a 2-wire cable which you can extend by fitting a junction box.

Standard	EN 13757-2 and -3
Reading interval	>1 min @ 2400 baud
Power supply	2 Batteries type AA

#### 9.2 Pulse output

The pulse exit permits the output of pulses that can be derived from the energy, the volume or the error status.

Two channels are available whose functions can be parameterized with the service software or who can be adapted in “Para menu” of the meter.

Output takes the form of standard pulses or as “high-definition pulses”.

The pulse duration is identical for channel 1 and channel 2.

Cable labelling	passive pulse output
Cable	1.5 m; 4-wired, LL84201 4xAWG28 / 0.2 mm <sup>2</sup>
Cable diameter	4 mm
Output type	open drain
Voltage	max. 30 V
Current	max. 30 mA
Dielectric strength	500 V <sub>eff</sub> against ground
Classification	OB/OC (according to EN 1434-2)
ON/OFF resistance	100 Ω / 6 MΩ
Output connection	

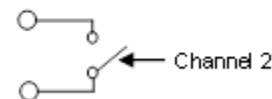
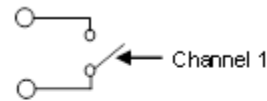

### 9.3 Wireless M-Bus

The wireless M-Bus function enables the meter to communicate with a stationary unit (radio concentrator, MUC – Multi Utility Controller) or a mobile unit (Handheld, e.g. pocket pc) using 868 MHz radio frequency (unlicensed).

The function supports the OMS<sup>1)</sup>-compliant data transfer.

The wireless M-Bus function is available with integrated antenna.

Standard	Open Metering System Specification (Issue 3.0.1); EN 13757-4
Frequency	868.95 MHz (min. 868.90 MHz to max. 869.00 MHz)
Transmission power	Min. 3.16 mW (5 dBm) to max. 25 mW (13.9 dBm)
Range <sup>2)</sup>	
- Free field	Up to max. 400 m
Power supply	3 batteries type AA
Sending interval	
- Mobile data reading	20 s
- Stationary data reading	15 min
- User defined data reading	Acc. to telegram length 12 – 900 s

<sup>1)</sup> Open Metering System

<sup>2)</sup> May vary depending on terrain and building structure

#### Data telegram F000 – stationary radio (sending interval 15 min.)

Following data are available by default for data reading:

- Current energy
- Current volume
- Current flowrate
- Current power
- Current temperature hot side
- Current temperature cold side
- Error (manufacturer specific)
- Current timestamp (type I)

#### Data telegram F001 – mobile data reading (sending interval 20 sec., battery life time 6 years)

Following data are available by default for data reading:

- Current energy
- Current volume
- Energy: previous month on reference date
- Volume: previous month on reference date
- Monthly reference date
- Energy: previous year on reference date
- Annual reference date
- Error (manufacturer specific)
- Current timestamp (type I)



**Note:** Please tell us if encryption needs to be set at factory. The unique encryption key for every meter will be created and you will get a file by email (meter number <> encryption key).

## Data telegram F002 – mobile data reading (sending interval 20 sec., battery life time 11 years)

---

Following data are available by default for data reading:

- Current energy
- Energy: previous month on reference date
- Monthly reference date
- Energy: previous year on reference date
- Annual reference date
- Error (manufacturer specific)
- Current timestamp (type I)



**Note:** Please tell us if encryption needs to be set at factory. The unique encryption key for every meter will be created and you will get a file by email (meter number <> encryption key).

---

## 10 Error codes

The meter continuously runs a self-diagnosis and can thus recognize and display various installation or error messages.

Error code	Error	Service guidelines
<b>FL neG</b>	Incorrect flow direction	Check flow or installation direction; correct if necessary
<b>if necessary in exchange with:</b>		
<b>DIFF nEG</b>	Negative temperature difference	Check installation point of the temperature sensors; exchange if necessary
<b>if necessary in exchange with:</b>		
<b>F0</b>	No flow can be measured	Air in the measurement unit/pipe; bleed air from line (delivery condition)
<b>F1</b>	Interruption in the hot side temperature sensor	Inform service department
<b>F2</b>	Interruption in the cold side temperature sensor	Inform service department
<b>F3</b>	Electronics for temperature evaluation defective	Inform service department
<b>F4</b>	Problem with the power supply; Battery flat	Inform service department
<b>F5</b>	Short-circuit hot side temperature sensor	Inform service department
<b>F6</b>	Short-circuit cold side temperature sensor	Inform service department
<b>F7</b>	Fault in internal memory holding	Inform service department
<b>F8</b>	Errors F1, F2, F3, F5 or F6 for longer than 8 hours, recognition of attempts to manipulate. No further measurements are carried out.	Measure dependent on error code. Error message F8 must be reset by service department.
<b>F9</b>	Fault in the electronics	Inform service department



**Note:** Reset the message F8 in the parameterization mode manually or with the service software. All other error messages are deleted automatically once the error has been rectified.

## 11 Order codes (type number key)

Mandatory data for the order designation  
(label plate data)Mandatory data for Hardware-  
dependent features

Type code:

T 2 3 0 - X X X X - X X X X - X - X X - X X - X X X

1. Meter type and mounting location
2. Nominal flowrate
3. Control cable/ type/ electronic unit
4. Country/ where used
5. Manufacturer's label
6. Sensor type and connection method
7. Sensor design
8. Power Supply
9. Communication
10. Calibration/ conformity
11. Energy unit

Order codes for label plate data	
<b>1. Type of meter and mounting location</b>	<b>Code</b>
Heating meter for two wire temperature measurement, mounting place cold side	A
Heating meter for two wire temperature measurement, mounting place hot side	B
Cooling meter for two wire temperature measurement, mounting place hot side (only in connection with temperature sensor Pt500)	G
Cooling meter for two wire temperature measurement, mounting place cold side	H
<b>2. Nominal flowrate</b>	<b>Code</b>
Nominal flowrate 0.6 m <sup>3</sup> /h, length 110 mm, nominal pressure PN16, connection G ¾ B	05
Nominal flowrate 1.5 m <sup>3</sup> /h, length 110 mm, nominal pressure PN16, connection G ¾ B	21
Nominal flowrate 1.5 m <sup>3</sup> /h, length 130 mm, nominal pressure PN16, connection G 1	26
Nominal flowrate 2.5 m <sup>3</sup> /h, length 130 mm, nominal pressure PN16, connection G 1 B	36
<b>3. Control cable / type / electronic unit</b>	<b>Code</b>
Split version with 1.5 m control cable	C
<b>4. County / where used</b>	<b>Code</b>
Dial plate for Middle East (English)	AE
Dial plate for Austria (German)	AT
Dial plate for Belarus (Russian)	BY
Dial plate for Switzerland (German/French)	CH
Dial plate for China (Chinese)	CN
Dial plate for Czech Republic (Czech)	CZ
Dial plate for Germany (German)	DE
Dial plate for Denmark (Danish)	DK
Dial plate English neutral	EN
Dial plate for Spain (Spanish)	ES
Dial plate for Great Britain (English)	GB
Dial plate for Italy (Italian)	IT
Dial plate for Norway (Norwegian)	NO
Dial plate for Poland (Polish)	PL
Dial plate for Russia (Russian)	RU
Dial plate for Sweden (Swedish)	SE
Dial plate for Slovenia (Slovenian)	SI
Dial plate for Slovak Republic (Slovakian)	SK
Dial plate for Uzbekistan (Russian)	UZ
<b>5. Manufacturer's label</b>	<b>Code</b>
Logo Landis+Gyr	00
Other labels on request	xx

<b>6. Sensor type and method of connection</b>	<b>Code</b>
Sensor Pt500, not removable, mounted in the tube	P
Sensor Pt500, not removable, mounting in the tube as an option	Z
<b>Hardware-dependent features</b>	
<b>7. Sensor type</b>	<b>Code</b>
Type PS, 16 bar / 95 °C / Ø5.0x45 mm, cable length 1.5 m	0F
Type PS, 16 bar / 95 °C / Ø5.0x45 mm, cable length 5 m	0G
Type PS, 16 bar / 95 °C / Ø5.2x45 mm, cable length 1.5 m	0H
Type PS, 16 bar / 95 °C / Ø5.2x45 mm, cable length 5 m	0J
<b>8. Power supply</b>	<b>Code</b>
Standard battery for 6 years (1xAA cell)	A
Battery for 6 years (3xAA cells)	C
Battery for 11 years (2xAA cells)	E
Battery for 11 years (3xAA cells)	F
<b>9. Communication</b>	<b>Code</b>
No module	0
M-Bus module	B
Wireless M-Bus module 868 MHz	E
Pulse module	L
<b>12. Calibration / conformity</b>	<b>Code</b>
Certified acc. to national regulations	CL
Compliant to MID class 2	M2
Compliant to MID class 3	M3
Compliant with CEN 1434, class 2	T2
Compliant with CEN 1434, class 3	T3
Compliant acc. to national regulations	TL
<b>13. Energy unit</b>	<b>Code</b>
Display: kWh (until qp 2.5)	A
Display: MWh with 3 decimal places (until qp 2.5)	B
Display: MJ (until qp 2.5)	C
Display: GJ with 3 decimal places (until qp 2.5)	D
<b>Further features</b>	
<b>Measurement dynamics</b>	<b>Code</b>
Dynamic range 1:100	C
Other ranges on request	

\*) Additional ordering information needed (see page 23)

## 12 Additional ordering information for wireless M-Bus



**Note:** The battery life time always depends on the meter configuration (Q & T measurement) and on the data telegram length, encryption (with / without) and sending interval (mobile / stationary)!

**All these configurations can be changed with the service software!**



**Note:** Data in the radio module is updated every 15 minutes.



**Note:** Standard from factory is “stationary radio”.

Necessary additional ordering information's:

- You must decide for “stationary radio (sending interval 15 min.)” or “mobile data reading (sending interval 20 sec.)”.
- Please tell us if encryption needs to be set at factory.
- The unique encryption key for every meter will be created and you will get a file by email (meter number <> encryption key).

### 1. Stationary radio

Ordering example battery life **6 years**, data telegram F000:

T230-XXXX-XXXX-X-XX-**CE**-XXX + F000 + 15 min. + encryption

C = battery life **6 years**

E = wireless M-Bus function

F000 = stationary radio

15 minutes = sending interval

Encryption (AES 128) = Yes / No

Ordering example battery life **11 years**, data telegram F000:

T230-XXXX-XXXX-X-XX-**FE**-XXX + F000 + 15 min. + encryption

F = battery life **11 years**

E = wireless M-Bus function

F000 = stationary radio

15 minutes = sending interval

Encryption (AES 128) = Yes / No

### 2. Mobile data reading “walk by”

Ordering example battery life **6 years**, data telegram F001:

T230-XXXX-XXXX-X-XX-**CE**-XXX + F001+ 20 sec. + encryption

C = battery life **6 years**

E = wireless M-Bus function

F001 = mobile data reading

20 seconds = sending interval

Encryption (AES 128) = Yes / No

Ordering example battery life **11 years**, data telegram F002:

T230-XXXX-XXXX-X-XX-**FE**-XXX + F001+ 20 sec. + encryption

F = battery life **11 years**

E = wireless M-Bus function

F002 = mobile data reading

20 seconds = sending interval

Encryption (AES 128) = Yes / No



### 13 Pressure loss

Nominal flowrate qp	Overall length	Connection	Pressure loss at qp	Kv-Factor at Δp 1 bar	Graph in diagram
m <sup>3</sup> /h	mm		mbar	m <sup>3</sup> /h	
0,6	110	G 3/4	75	2.2	A
1,5	110, 130	G 3/4, G1	135	4.1	B
2,5	130	G1	135	6.8	C

The indicated pressure loss of a flow sensor is at the nominal flowrate qp.  
Using the Kv-Factor, which defines the flow rate at a pressure loss of 1 bar, the pressure loss at any given flow rate can be calculated:

$$\Delta p = 1 \text{ bar} \times \left( \frac{Q}{K_v} \right)^2$$

$\Delta p$  = pressure loss in bar

$Q$  = flowrate in m<sup>3</sup>/h

$K_v$  =  $K_v$  - Factor at  $\Delta p = 1$  bar

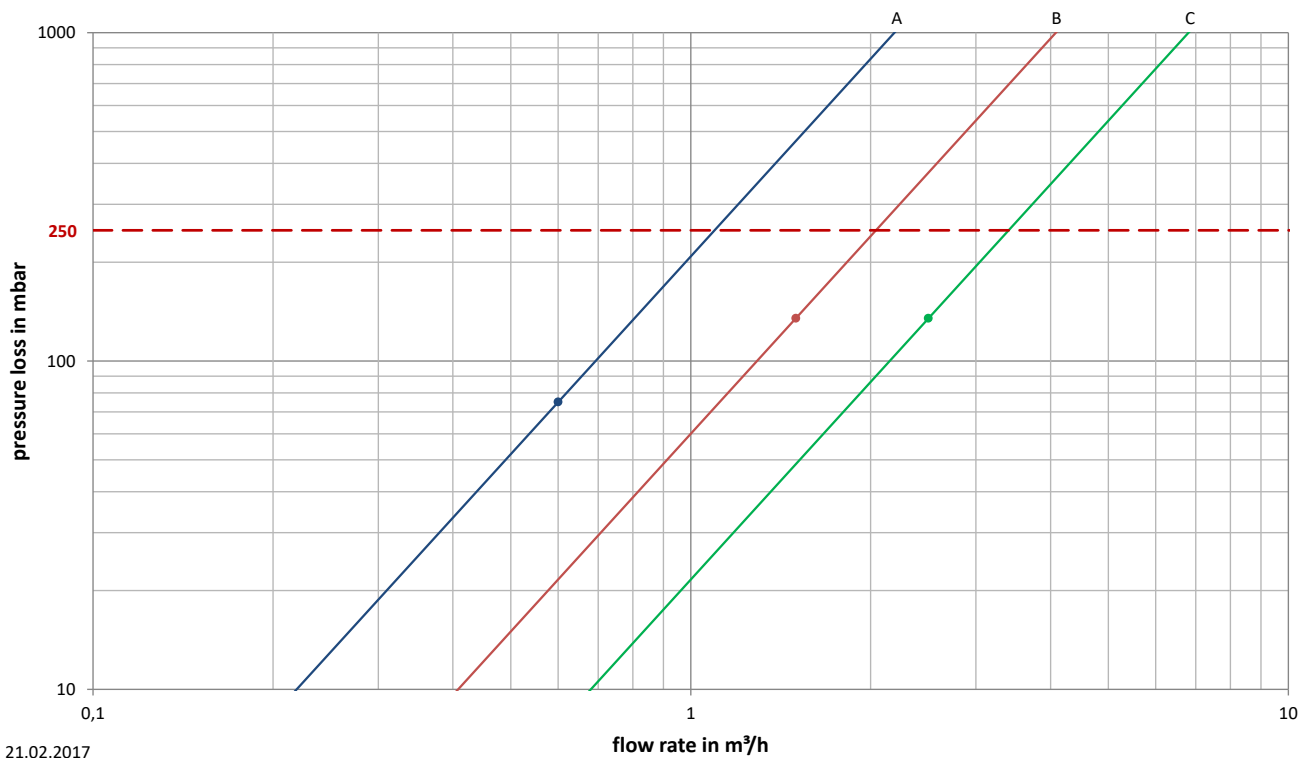

Landis+Gyr GmbH  
Humboldtstrasse 64  
90459 Nuremberg  
Germany

---